



CATALOGUE

DVI Connector



Range Overview

∟ Receptacle to Overmolded with Cable

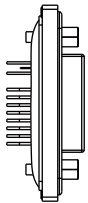

Receptacle

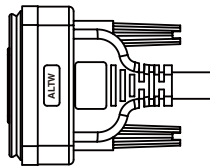

Overmolded with Cable

∟ Accessories

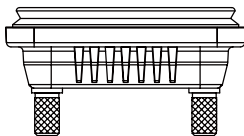

Waterproof Cap

Specification

Identifications	DVI-D Single Link (DDS) : Digital DVI-D Dual Link (DDD) : Digital DVI-I Single Link (DIS) : Digital and Analog DVI-I Dual Link (DID) : Digital and Analog
Description	Receptacle Overmolded with Cable
Current Rating / Data	1.5A
Material	Contacts: Cooper Alloy, Gold Plated Connector Body (Housing): Nylon + GF, UL Recognized Shell: Steel, Nickel Plated
Waterproof Rating	Receptacle: IP68 Overmolded with Cable: IP67
Temperature Range	Receptacle: -20°C~80°C Overmolded with Cable: -20°C~80°C
Contact Resistance	≤ 20mΩ
Insulation Resistance	≥ 1000MΩ at DC500V
Durability	100 cycles
Breakdown Voltage	≥ AC 500V / 1 minute
More to know	Standard Cable Length: 01~05M

【Note】 Design and specification are subject to change without notice.

Ordering Information



Specification

(DIS) DVI-I Single Link **(DDS)** DVI-D Single Link

(DID) DVI-I Dual Link **(DDD)** DVI-D Dual Link

* For digital and analog, please choose DVI-I

* For digital only, please choose DVI-D

Number of Contacts

19, 23, 25, 29... Contacts

e.g. 19 Pin = **(19)**

Connector Body (Style)

> For Receptacle

(P) Front Fastened

> For Overmolded with Cable

(A) With Strain Relief

Connector (Housing) Gender

(M) Male

(F) Female

Contact Gender

(M) Male

(F) Female

Assemble Style

> For Receptacle

(S) Solder Type

(P) Front Fastened

> For Overmolded with Cable

(M) Overmolded with Cable

Mating Style

(S) Screw Thread

Backshell

> For Receptacle

(L) Straight / Without Board Lock

> For Overmolded with Cable

(L) Straight

Waterproof Rating

(7) IP 67

(8) IP 68

More Information

> For Receptacle

(001), (002).....

Without Cable : Different Versions

> For Overmolded with Cable

(□)+(■) : Cable Type + Cable Length

e.g. **(A01)** = UL20276 Cable + 1M

(□) : Cable Type

(A) UL20276
28AWG/PVC

(■) : Cable Length

From 1M to 5M
e.g. **(01)** = 1M

Physical Dimension

Receptacle

Terminal: Solder Type

Panel Cut-Out

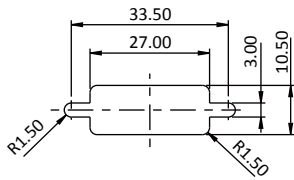

Connector Dimension

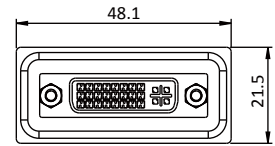
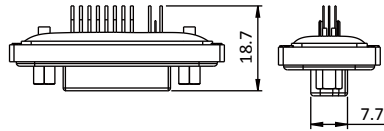

Terminal: PCB Type

Panel Cut-Out

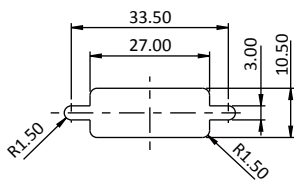

Connector Dimension

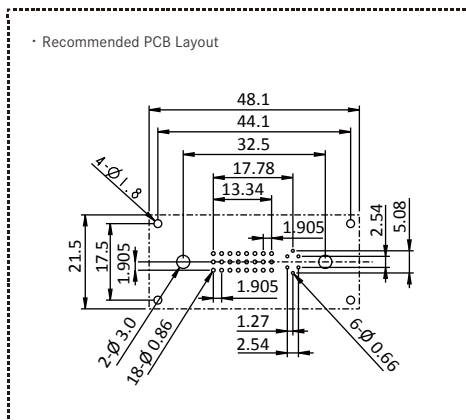
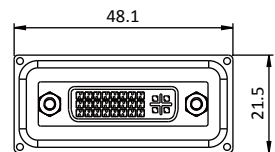
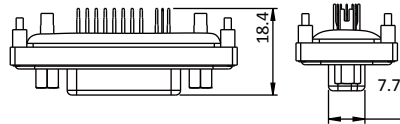

* Unit: mm

* The dimension is feasible for DVI-D Single Link(DDS), DVI-D Dual Link(DDD), DVI-D Singel Link(DIS), and DVI-D Dual Link(DID)

Overmolded with Cable

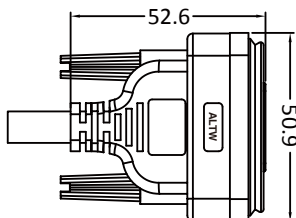

* Unit: mm

* The dimension is feasible for DVI-D Single Link(DDS), DVI-D Dual Link(DDD), DVI-D Singel Link(DIS), and DVI-D Dual Link(DID)

【Note】 Design and specification are subject to change without notice.

Contact Configuration

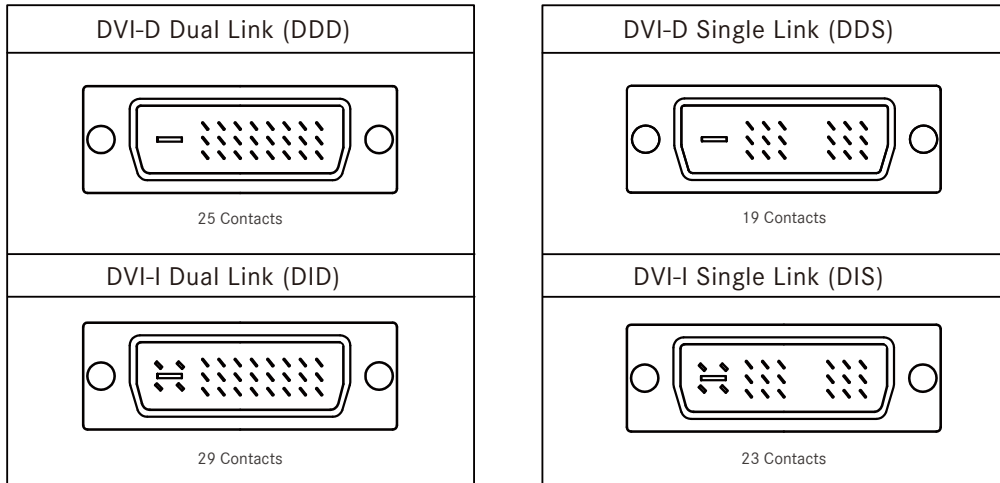

Product Features

Receptacle

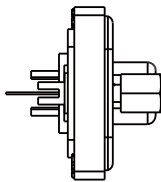

Backshell 8

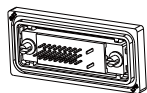

Straight (L)

Mating Style 7



Screw Thread (S)

Connector Body(Style) 3

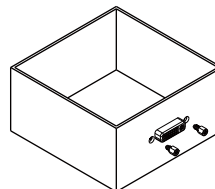

Front Fastened (P)

Overmolded with Cable

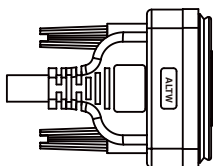

Backshell 8

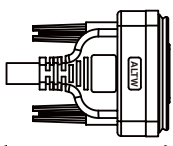

Straight (L)

Mating Style 7



Screw Thread (S)

Connector Body(Style) 3

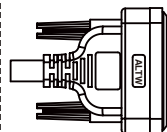

With Strain Relief (A)

Find Our Standard Products

▾ Receptacle and Mating Pair

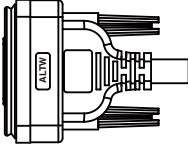
<ul style="list-style-type: none"> • Female Connector (Housing) • Female Contacts • Screw Thread • Terminal: Solder Type 	Receptacle ----->	Overmolded with Cable ----->	Field Installable
			
Code	Female Connector (F) Female Contacts (F)	Male Connector (M) Male Contacts (M)	Male Connector (M) Male Contacts (M)
DVI-D Single Link (DDS)	DDS-19PFFS-SL8001	DDS-19AMMM-SL7A <u>XX</u> *	-
DVI-D Dual Link (DDD)	DDD-25PFFS-SL8001	DDD-25AMMM-SL7A <u>XX</u> *	-
DVI-I Single Link (DIS)	DIS-23PFFS-SL8001	DIS-23AMMM-SL7A <u>XX</u> *	-
DVI-I Dual Link (DID)	DID-29PFFS-SL8001	DID-29AMMM-SL7A <u>XX</u> *	-

【Note】 For digital and analog, please choose DVI-I
 For digital only, please choose DVI-D

* XX: Choose UL20276 cable and select the cable length from 01~05m

▾ Receptacle and Mating Pair

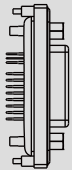
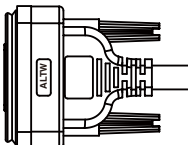
<ul style="list-style-type: none"> • Female Connector (Housing) • Female Contacts • Screw Thread • Terminal: PCB Type 	Receptacle ----->	Overmolded with Cable ----->	Field Installable
			
Code	Female Connector (F) Female Contacts (F)	Male Connector (M) Male Contacts (M)	Male Connector (M) Male Contacts (M)
DVI-D Single Link (DDS)	DDS-19PFFP-SL8001	DDS-19AMMM-SL7A <u>XX</u> *	-
DVI-D Dual Link (DDD)	DDD-25PFFP-SL8001	DDD-25AMMM-SL7A <u>XX</u> *	-
DVI-I Single Link (DIS)	DIS-23PFFP-SL8001	DIS-23AMMM-SL7A <u>XX</u> *	-
DVI-I Dual Link (DID)	DID-29PFFP-SL8001	DID-29AMMM-SL7A <u>XX</u> *	-

【Note】 For digital and analog, please choose DVI-I
 For digital only, please choose DVI-D

* XX: Choose UL20276 cable and select the cable length from 01~05m

【Note】 Design and specification are subject to change without notice.

Accessories

Waterproof Cap

■ Customized - Upon Request

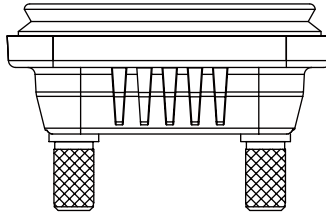

Type	Mating Pairs	Mating Style	Mating Pair (Gender)	P/N
DVI	Receptacle	Screw Thread	Male & Female	CAP-WDVCSPA1

Amphenol LTW Technology Co., Ltd.

5F-3, No.51, Sec.4, Zhongyang Rd., Tucheng Dist., New Taipei City 236, Taiwan
Telephone: +886-2-77416888 Fax: +886-2-77416999
www.amphenolltw.com

Kunshan Factory

No. 62, DaTong Road, Development Zone, Kunshan City, JiangSu Province, 215333 China
Telephone: +86-512-5761-0501
Fax: : +86-512-5761-0515

For further information, please contact :

Sales & Marketing Department | Email : sales@ltw-tech.com