

12 11 10 9 8 7 6 5 4 3 2 1

A

B

C

D

E

F

A

B

C

D

E

F

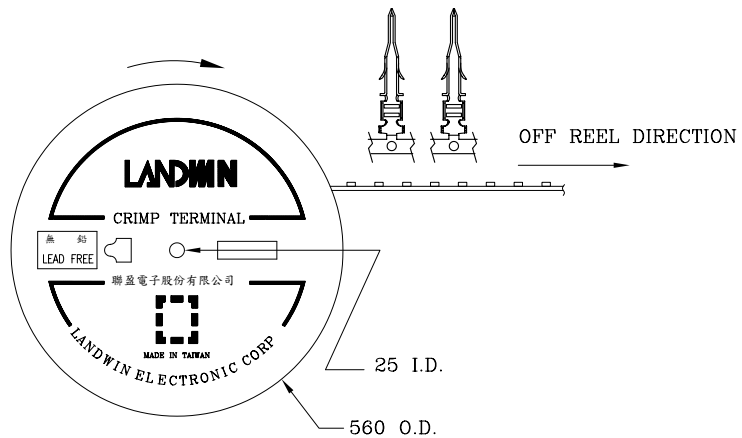

ROLL FORM PACKAGE

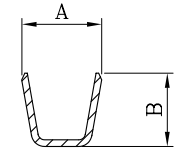
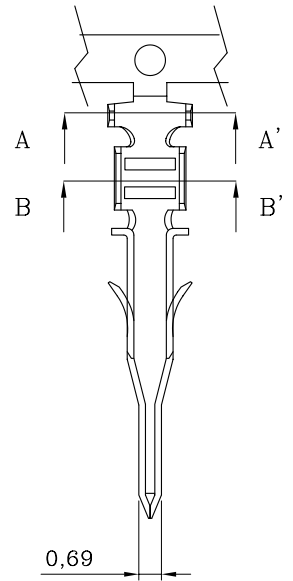
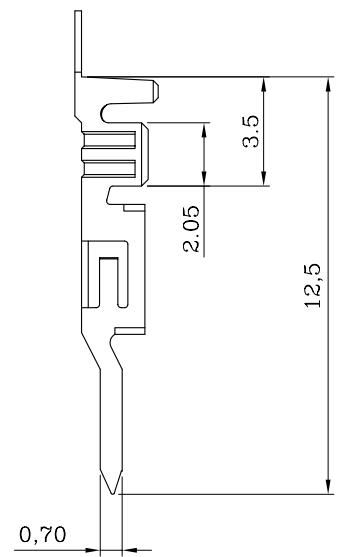

SEC.A-A'

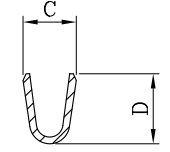

SEC.B-B'

DESCRIPTION OF ORDER NO.:

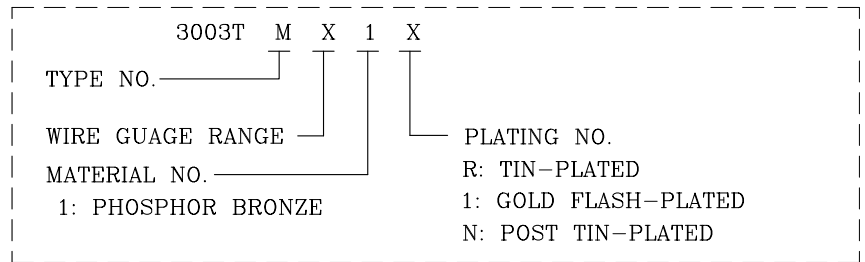

ORDER INFORMATION AND DIMENSION:

| ORDER NO. | TERMINAL TYPE | WIRE GAUGE RANGE (AWG) | INSULATION DIAMETER | Q'TY/REEL | A | B | C | D |
|-----------|---------------|------------------------|---------------------|------------|-----|-----|-----|-----|
| 3003TM11R | CHAIN | #20 ~ #24 | ø1.9 MAX. | 10,000 PCS | 2.7 | 2.5 | 2.1 | 2.1 |
| 3003TM21R | CHAIN | #26 ~ #30 | ø1.3 MAX. | 10,000 PCS | 2.4 | 1.9 | 1.8 | 1.6 |

NOTES:

- MATERIAL: PHOSPHOR BRONZE
- USE WITH 3000M SERIES PLUG HOUSING:
 - <1> 3000MXX11 SERIES
 - <2> 3000MXX21 SERIES
 - <3> 3000MXX11-XE SERIES
 - <4> 3000MXX21-XE SERIES
- INFORMATION IN THIS DRAWING IS NOT CONSIDERED AS FINAL.

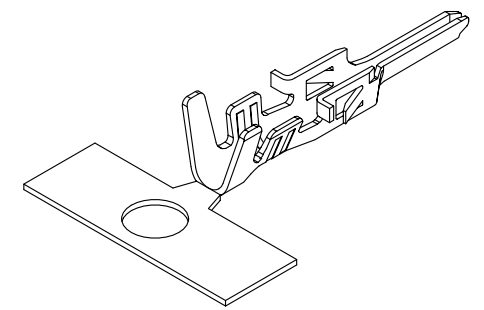

ISOMETRIC VIEW

| | | | | |
|--------------------|--|--|-------------|-----------------|
| | | Sales Drawing | | |
| | | 聯盈電子股份有限公司 LANDWIN ELECTRONIC CORP. | | |
| GENERAL TOLERANCE: | PROJECTION: FREE SCALE: FREE UNIT: MM | SHEET NO. | REV | |
| | DRAWN: R.G. | 1 / 1 | W1 | |
| | CHECKED: J.L.Lin | DRAW NO. (BQ) 3003TMX1X | | |
| | APPD: H.Y.Lin | TITLE: CRIMP TERMINAL (3000M SERIES) | | |
| W1 | NEW RELEASE | 31-DEC-14' | ANGULAR ±3° | DATE 31-DEC-14' |
| REV. | REVISION RECORD | DATE | | |