

ORDER INFORMATION AND DIMENSION:

Circuits	Part No. (PA66 94V-2, White color) (Tin-Plated)	Dimension	
		A	B
2	3061P0202T	3.96	7.92
3	3061P0302T	7.92	11.88
4	3061P0402T	11.88	15.84
5	3061P0502T	15.84	19.80
6	3061P0602T	19.80	23.76
7	3061P0702T	23.76	27.72
8	3061P0802T	27.72	31.68
9	3061P0902T	31.68	35.64
10	3061P1002T	35.64	39.60
11	3061P1102T	39.60	43.56
12	3061P1202T	43.56	47.52
13	3061P1302T	47.52	51.48
14	3061P1402T	51.48	55.44
15	3061P1502T	55.44	59.40

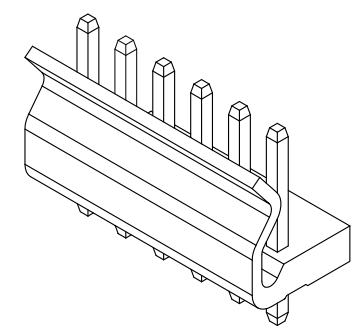

ISOMETRIC VIEW

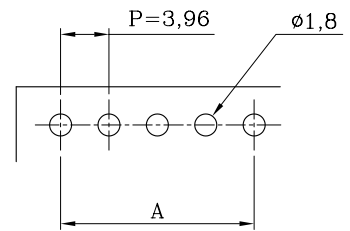
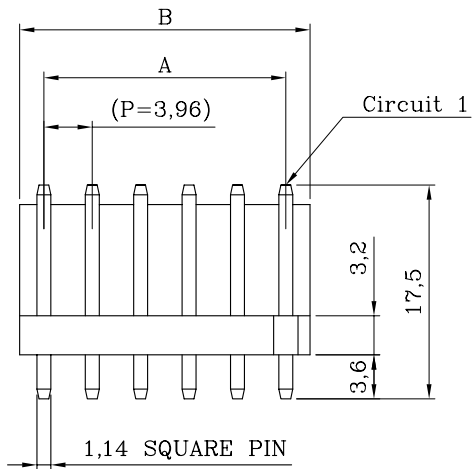
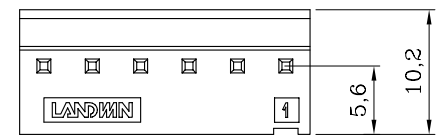
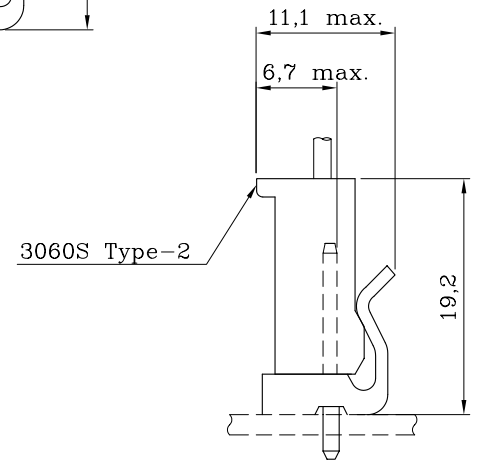
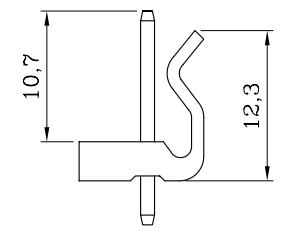

ASSEMBLY LAYOUT

DESCRIPTION OF ORDER NO.:

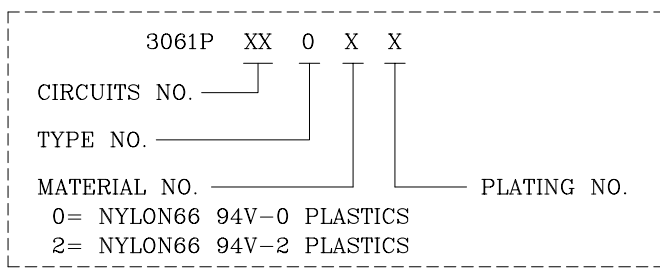

NOTES:

- MATERIAL:
BASE: NYLON66 94V-0 / 94V-2, WHITE COLOR (NATURAL)
CONTACT PIN: BRASS
- MATES WITH PLUG HOUSING: 3060SXX0X, 3060SXX2X, 3060SXX2X-SC, 3060SXX2X-SD, 3060SXXCX, 3060SXXDX.
- DESCRIPTION OF COLOR NO:
LEGEND: 3061PXXOXX-X (-X: COLOR CODE)
B=BLACK, C=COCONUT BROWN, E=BLUE, H=GRAY, I=BRICK RED,
- INFORMATION IN THIS DRAWING IS NOT CONSIDERED AS FINAL.

DESCRIPTION OF PLATING NO:	
T= TIN-PLATED (T/P)	1= GOLD FLASH-PLATED
V= MATTE TIN-PLATED	

P.C. BOARD LAYOUT
(COMPONENT SIDE)

MATERIAL: SEE NOTES	
FINISH(COLOR): SEE NOTES	
W1	NEW RELEASE
REV.	REVISION RECORD

		Sales Drawing			
聯盈電子股份有限公司 LANDWIN ELECTRONIC CORP.					
GENERAL TOLERANCE:	PROJECTION	SCALE	UNIT	SHEET NO.	REV
		FREE	MM	1 / 1	W1
	DRAWN	R.G.	DRAW NO.		
	CHECKED	J.L.Lin	(CQ) 3061PXXOXX		
	APPD	H.Y.Lin	TITLE:		
	DATE	31-DEC-14'	3.96 PITCH SINGLE-ROW S/T HEADER		