

66202S Receptacle Housing

■ Specifications

- ◇ Current rating: 20A AC/DC Max.
- ◇ Voltage Range: 24V AC,DC
- ◇ Withstand Voltage: 1200V AC/Minute
- ◇ Contact Resistance: 6 mΩ Max. before environment test
- ◇ Insulation Resistance: 1000 MΩ Min.
- ◇ Temperature Range: -30° C to 125° C

■ Reference

- ◇ Mates with 66201S series Plug Housing
- ◇ Use with 66202T series crimp terminal
- ◇ Applicable wire gauge: 0.51 mm² - 1.31 mm² (AWG 20 - 16)

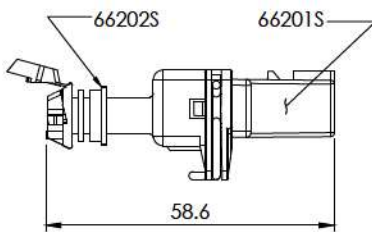
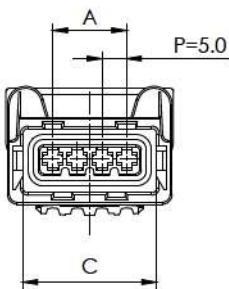
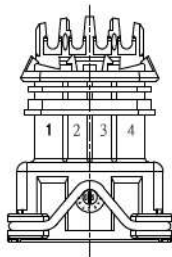
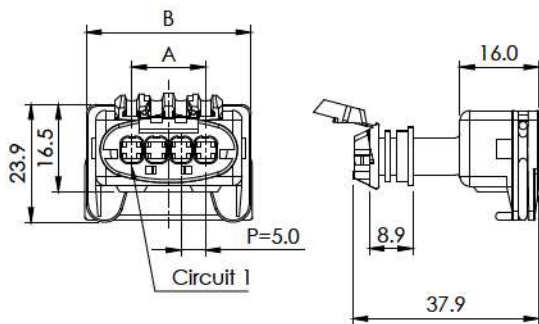
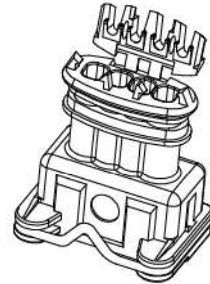

Assembly Layout

Ordering Information

PIN No.	Part No.	Dimension		
		A	B	C
2	66202S0203	5.0	23.6	17.4
3	66202S0303	10.0	28.5	22.2
4	66202S0403	15.0	33.5	27.2
5	66202S0503	20.0	38.5	32.2
6	66202S0603	25.0	43.5	37.2
7	66202S0703	30.0	48.5	42.2

Material

Part	Material
Housing	Nylon 66 94V-0, Black color
Clip	Stainless Steel

Specifications

- ◇ Current rating: 20A AC/DC Max.
- ◇ Voltage Range: 24V AC,DC
- ◇ Withstand Voltage: 1200V AC/Minute
- ◇ Contact Resistance: 6 mΩ Max. before environment test
- ◇ Insulation Resistance: 1000 MΩ Min.
- ◇ Temperature Range: -30° C to 125° C

Reference

- ◇ Mates with 66201S series Plug Housing
- ◇ Use with 66202T series crimp terminal
- ◇ Applicable wire gauge: 0.51 mm² - 1.31 mm² (AWG 20 - 16)

66202S Receptacle Housing (Type 1, 2)

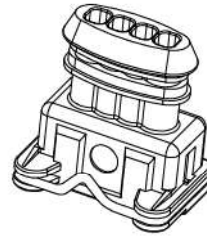

Type-1

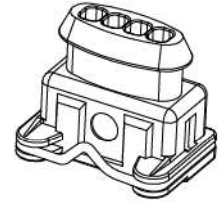

Type-2

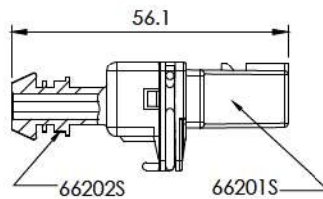
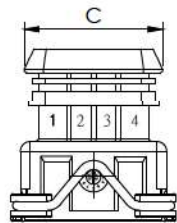
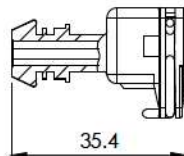
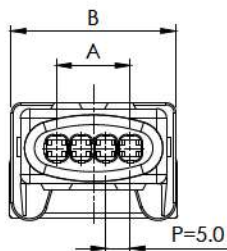

66202SXX13

Assembly Layout

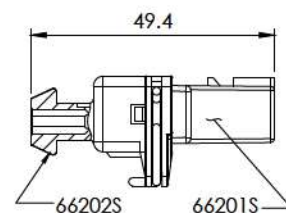
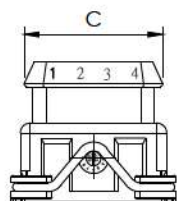
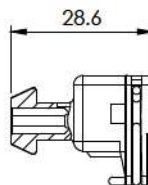
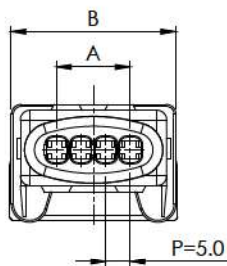

66202SXX23 (Low-Profile)

Assembly Layout

Ordering Information

PIN No.	Part No.		Dimension		
	W/O Cover	Low Profile	A	B	C
2	66202S0213	66202S0223	5.0	23.5	16.8
3	66202S0313	66202S0323	10.0	28.5	24.5
4	66202S0413	66202S0423	15.0	33.5	28.0
5	66202S0513	66202S0523	20.0	38.5	33.0
6	66202S0613	66202S0623	25.0	43.5	37.8
7	66202S0713	66202S0723	30.0	48.5	43.0

Material

Part	Material
Housing	Glass-filled PBT 94V-0, Black color
Clip	Stainless Steel