

- CAT6A Class EA RJ45 plug to be assembled in the field
- FTP TYPE: 1 piece Design
- Easy Assembly - easily terminated in the field in 2 minute without any special tools
- Operation temperature: -40 °C to 60 °C, Relative humidity: 85%(30 °C), Air pressure: 70-106Kpa.
- Gold Plated Phosphor Bronze Blade: phosphor bronze and gold plating (3~50uinch), mating durability not less than 750 cycles :
- Anti-burn performance: product made from Krsite \ PC
- Intermediate resistance: no more than 20m ohm in normal atmosphere pressure (not including bulk resistor) :
- Insulated resistance: no less than 1,000M ohm in normal atmosphere pressure :
- Intensity of anti-current: DC 1,000V (AC,700V), no puncture and flash-over phenomenon in one minute :
- Retention strength: 7.7kg between jack and plug.
- Label: clear label to ensure easy to management :
- Cable Jacket Diameter from 6 to 8.3 mm

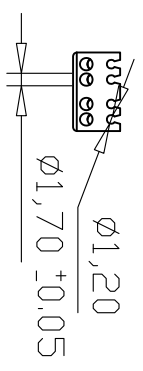

WIRING CAP

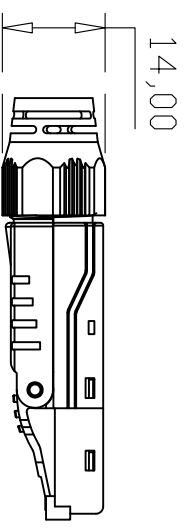
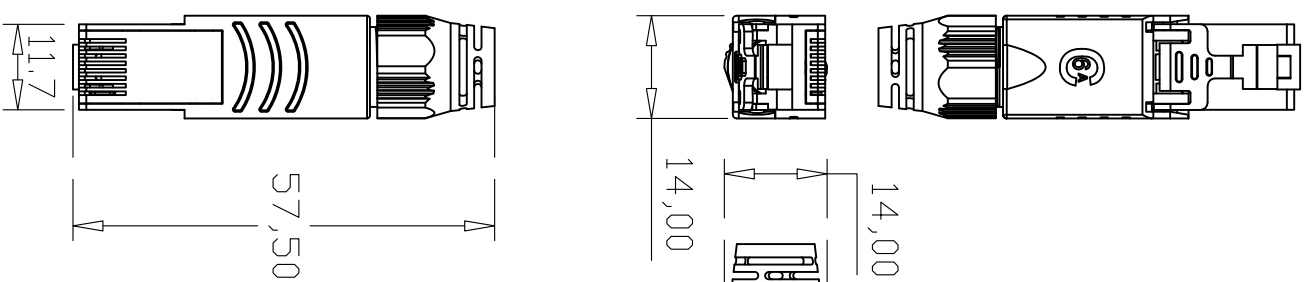
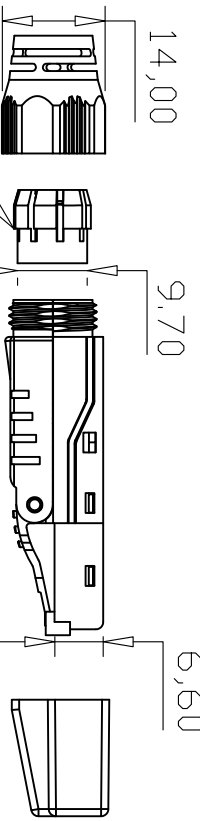
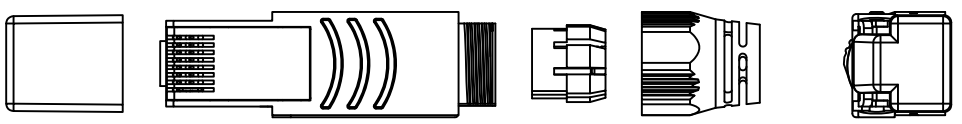
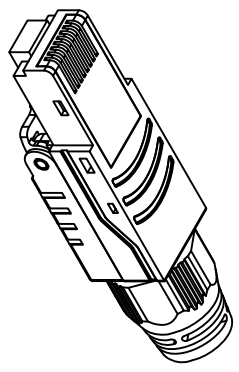

Environmental
chromium plating

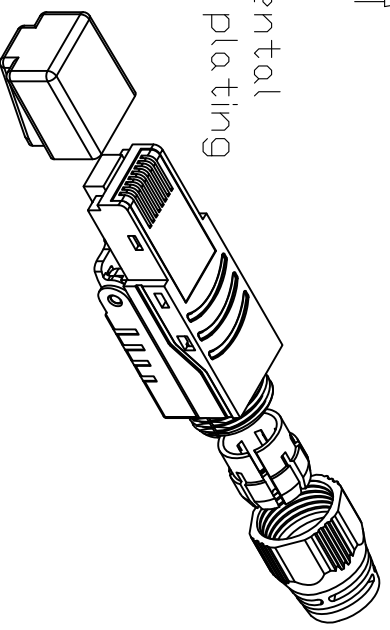

TITLE:		P/N:	
.X	.015	.30	
.XX	.010	.10	
.XXX	.005	.05	

DRAWN BY	MA	SCALE	1:1	REV	
CHECK BY		UNIT	MM		
APPD BY		SHEET	1/1	DWG NO:	
		DATE	2019/01/10		